

INSTALLATION PROCEDURES - High Groundwater

These installation instructions apply to sites with high groundwater.

Step 1: Site Preparation & Notes

- Read "Key Roth Installation Facts" first (applies to Roth MultiTank® OR the FRALO Septec Tank)
- Max burial depth is 36" below grade, unless deep burial instructions (steps 11 & 12) on "Key Installation Facts" are followed.
- Absolutely no clay should be used for backfill.
- Inspect tank for any damage during handling or transportation.
- Tank must be uniformly supported.
- Failure to properly bed tank and compact fill will void the warranty.
- Absolutely no water is required for backfill. The tank is designed to be backfilled without water. Filling the tank with water prior to backfilling is not necessary and may cause installation problems. A nominal amount of water (6-8") may be used to ballast the tank during backfilling.

Step 2: Excavation Size

- Width and length of excavation shall be 12-18" greater than the tank on all sides and ends (FIG.1).
- Depth of the excavation shall be 6" greater than the tank (FIG.1).
- Lengthen and deepen excavation at one end to provide dewatering pit as necessary.
- Do no over excavate or "belly-out" the excavation.

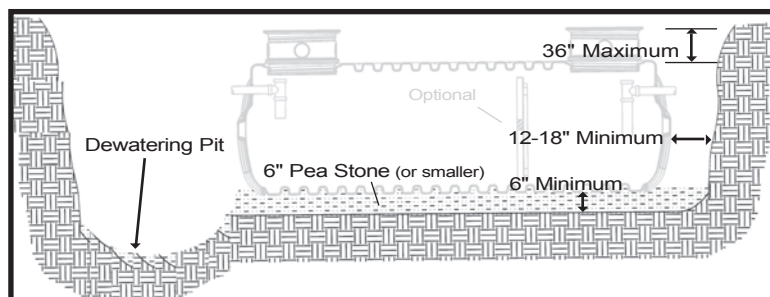

FIG.1 Excavation

Step 3: Bedding the Tank

- Add pea stone, sand, gravel or other similar granular material to bed the tank and ensure uniform compaction and that bed is level (FIG.1)
- Native material may be used to bed the tank providing it is properly placed and compacted.
- Keep excavation free of water at all times.

Step 4: Tank Installation

- Prepare the tank for installation. Identify the inlet and outlet ends of the tank. Inlet and outlet may be located on the end or either side ports (per code requirements).
- For standard installation, identify drill location A (40" Liquid Level). Drill the inlet and outlet holes using a 5-inch diameter hole saw. (FL & IN tanks are pre-drilled)
- * **IMPORTANT NOTE: For AZ, IL, NE drill dimple B (42" Liquid Level). Florida & Indiana tanks are pre-drilled at the factory.**
- Install provided rubber gasket in inlet and outlet ports. (Fig. 2)

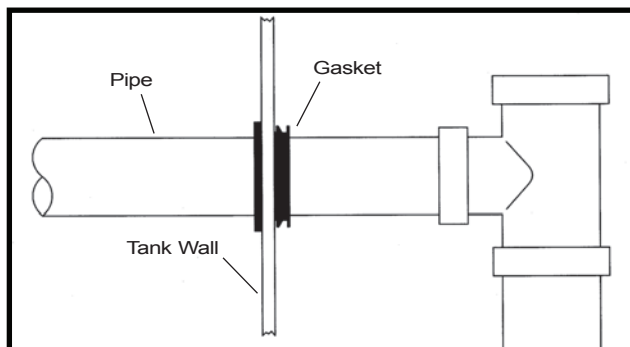

FIG.2 Gasket Detail

- Install the inlet and outlet tees, as required. (Fig. 3) Plumbing tees shall be located as close to the entrance point of the tank as possible (just inside the manway opening). Plumbing tees and gas-baffles are factory provided for Indiana tanks.

Step 4: Tank Installation (cont'd)

- Install the required Roth threaded Septic Access Riser System (STAR™), provided separately. (Fig. 3) See reverse for directions for sealing the riser system.
- Using the corner lifting holes, lower the tank into the excavation. Level the tank, and verify the outlet is lower than the inlet. Install remaining inlet and outlet plumbing. (Fig. 3)

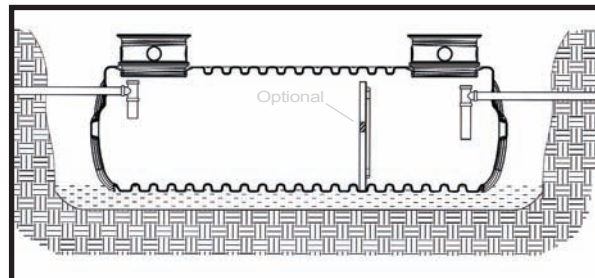

FIG.3 Plumbing Install

- Perform required water tightness, plumbing and/or tank inspection if applicable.

Step 5: Backfill

- Backfill in an alternating method around the tank using native material free of debris, sharp stones, and stones greater than 2" in diameter. Soil MUST flow freely into corrugations between tank ribs, including midpoint to belly of tank.
- Compact backfill in 6 inch lifts always working on the sides first and then the bulkheads (ends of tank).
- Stop backfilling 6" under mold part-line and add concrete collar.
- Add 16" W x 12" T concrete collar all the way around tank with 2-#4 rebar as shown.
- Use a hand tamper to achieve sidewall compression through compacted backfill. Mechanical compactors may be used if available on the site. Sidewall compression is essential to provide sidewall restraint after covering the tank. (Fig. 4)

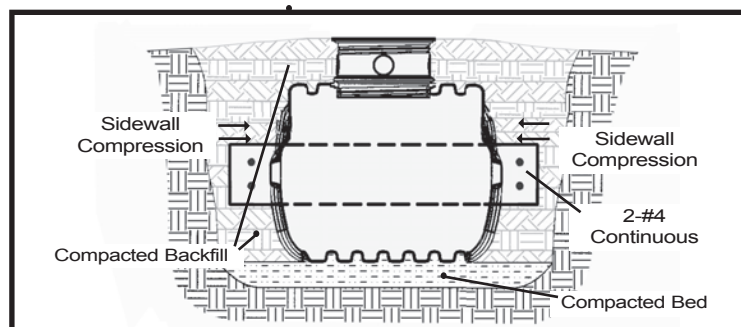

FIG.4 Backfilling

- When backfilling the top of the tank, backfill between risers first.
- Complete backfilling and grade the area.
- Failure to compact fill voids the tank warranty.



WARNING

- Tanks are designed for underground use only.
- Installer shall comply with all federal, state, and local regulations.
- Tanks are not rated for vehicular traffic. Avoid operation of vehicles heavier than 2500 pounds over the tank.
- Internal water temperatures should not exceed 140° F.
- Verify no underground utilities or pipes are located in the excavation vicinity.
- Where saturated soil or seasonal high water tables are indicated between the bottom of the tank and the ground surface, see separate supplemental installation instructions for these site conditions.
- Secure tank access by installing provided stainless steel fastener to the riser and cover.

Roth Global Plastics, Inc.

INSTALLATION PROCEDURES

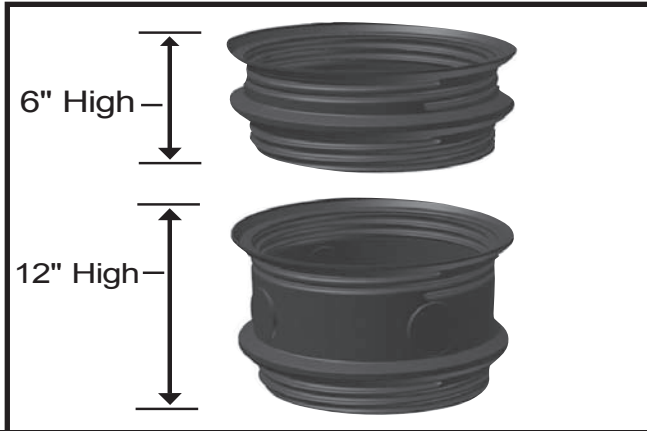

FIG.1 Riser Elevation

STEP 1 Determine riser elevation and required riser combination as per tank installation (see reverse). STAR™ risers are available in 6" (STAR-24R6) and 12" (STAR-24R12) height increments. (Fig.1)



FIG.2 Apply Gasket

STEP 2 Apply gasket (not included*) on the innermost flat ring on the tank surface. Be careful not to allow the gasket to overhang the threads where it would interfere with the thread engagement. (Fig.2)
*Indiana tanks and risers include gaskets.

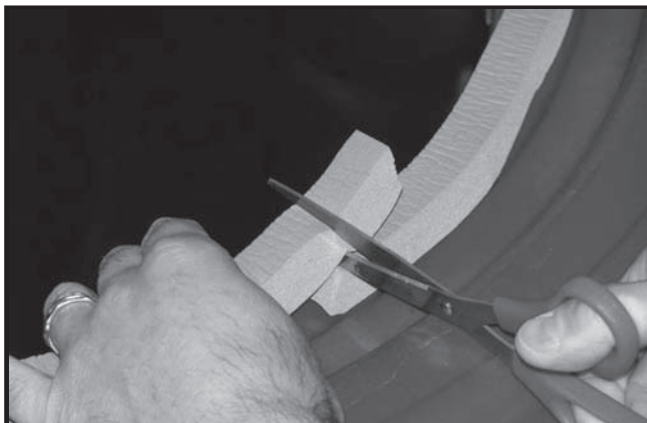

FIG.3 Trim Gasket

STEP 3 Trim gasket 1/4" too long. A properly trimmed gasket is then compressed end to end. Ensure that the gasket is uniformly positioned and makes good contact with the tank surface. (Fig.3)



FIG.4 Install Riser

STEP 4 Screw the riser into the tank joint, being careful that the gasket remains in position. Properly installed, the gasket should show uniform compression around the entire joint. (Fig.4)



FIG.5 Additional Gaskets

STEP 5 Apply the gasket on the first riser on the thread portion which is facing up. (Fig.5). Trim the gasket to connect the pieces end to end. Screw the additional riser(s) into position.

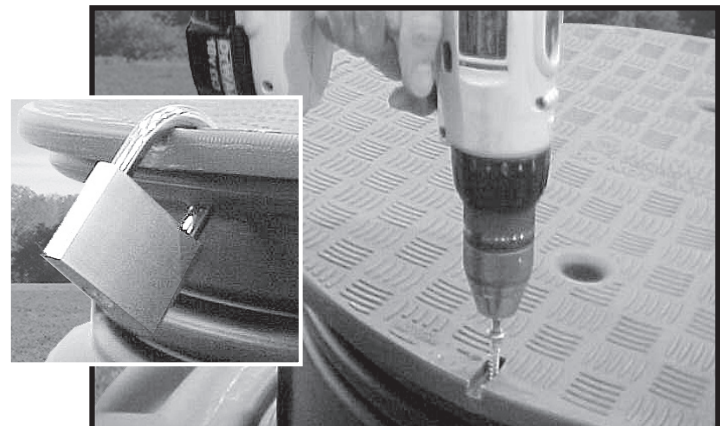

FIG.6 Secure Cover

STEP 6 Locate the "Secure Here" hole on the cover and install a tamper-resistant screw (STAR-SSCREW provided) through the lid and into the riser below. (Fig.6) To secure with padlock, drill a larger hole to accommodate the lock.

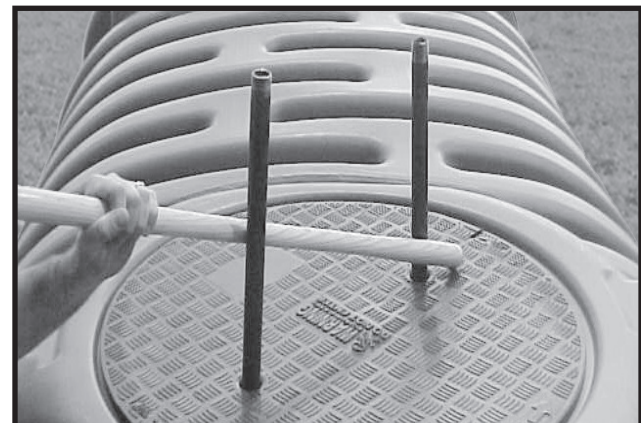

FIG.7 Remove Cover

STEP 7 If unable to remove cover by hand, insert 1" OD steel pipe into cover indentations and twist using a shovel handle, pipe or piece of wood. (Fig.7)



- To prevent unauthorized access, never install STAR™ Riser System without the factory provided tamper resistant screw.
- Not rated for vehicular traffic loading.

HIGH GROUNDWATER

HIGH GROUNDWATER

HIGH GROUNDWATER

Roth Global Plastics, Inc.